

NV2 - 12

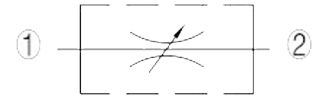
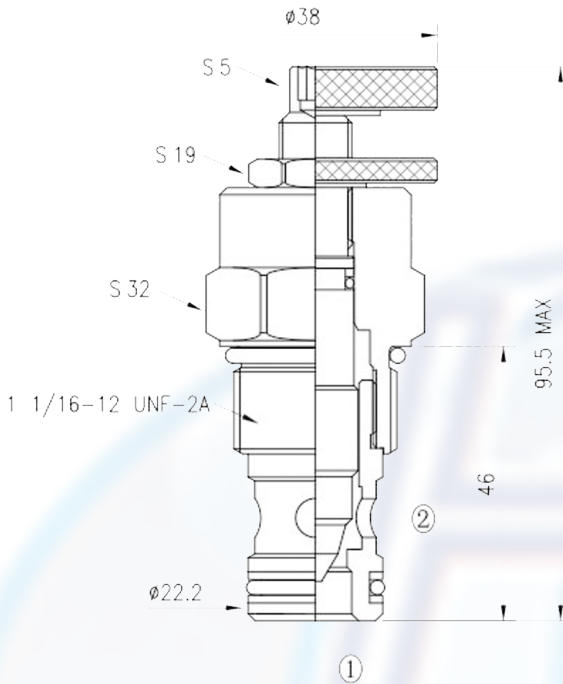

SPECIFICATION:

Max working pressure:	250bar
Flow max:	see performant chart
Internal leakage:	3 drops/min
Filtration of oil:	25m or better
Temperature:	-30 ~ +110°C
Cavity:	12 - 2
Installatin torque:	45 ~ 50Nm

PERFORMANCE

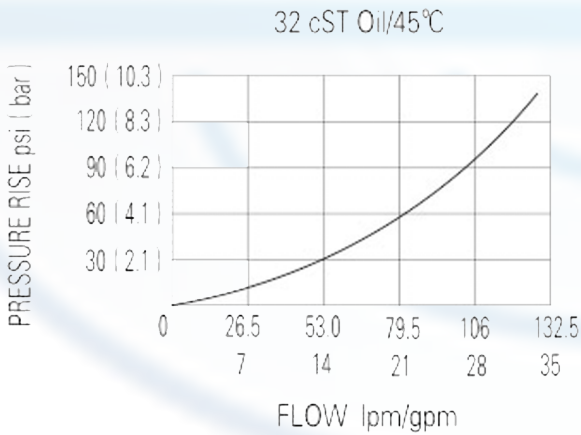

The valve increases its orifice valve from fully closed to fully open with counterclockwise adjustment rotation.

to order:

