

SV6 - 12 - 2NCP

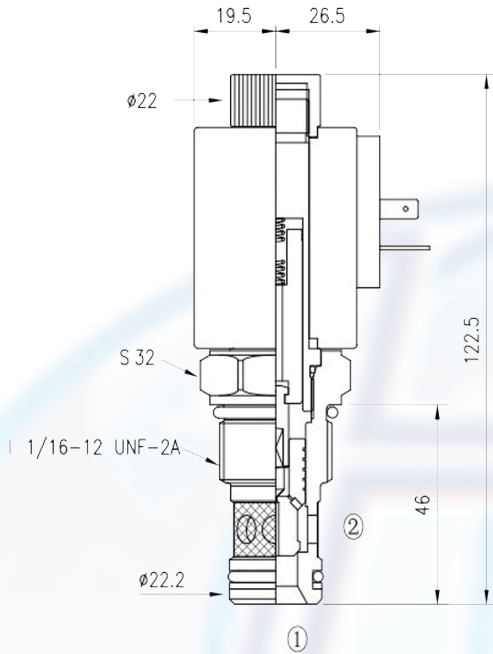
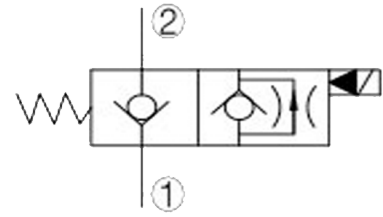

SPECIFICATION:

- Max working pressure: 250bar
- Flow max: see performant chart
- Internal leakage: 3 drops/min / 210bar
- Filtration of oil: 25m or better
- Temperature: -30 ~ +100°C
- Cavity: 12 - 2
- Installatin: 45 ~ 50Nm
- Coil rating: 85% ~ 110%

Continuous from 85% to 110% of rated voltage

PERFORMANCE

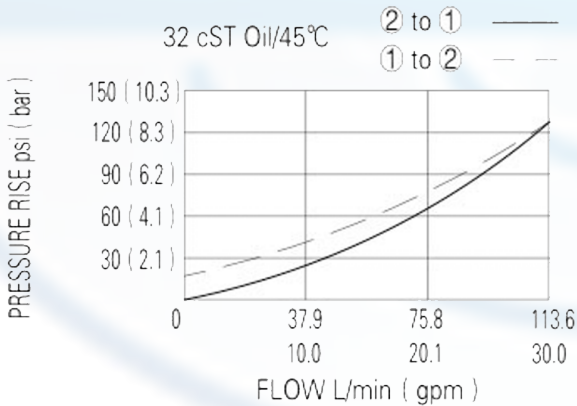

When de-energized, the valve acts as a check valve, allowing flow from 1 to 2, while blocking flow from 2 to 1;
 when energized, allowing flow from 2 to 1, while 1 to 2 is serverly restricted

to order:

SV6 - 12 - 2NCP - □ - □

cavity
function

voltage:

- 12 = 12V DC
- 24 = 24V DC
- 110 = 110V AC
- 220 = 220V AC

coil connection:

- D = Double Lead
- H = Hirschmann